

Panasonic

AG-CX10

The Smallest, Lightest* 4K 60p Camcorder



The mics shown in product photos are optional.



* For a camcorder with an integrated lens capable of 4K 60p recording (as of January 6th, 2020, according to a Panasonic research).



The Smallest, Lightest*¹ 4K 60p Camcorder

Professional camcorders combine power with mobility. These compact units enable high-quality 4K 60p recording with the excellent portability required for professional use. They deliver a high-spec optical performance with a wide-angle 25mm*² lens and optical 24x zoom featuring Face Detection AF/AE. Professional functions include Two Manual Rings, an ND Filter, a Built-in LED Video Light and 24-bit High-Resolution PCM Audio Recording.

Video acquisition utilizes 4:2:2 10-bit internal recording*³ and the new HEVC (High-Efficiency Video Coding) codec for video compression. HD live streaming is possible with the camcorder body alone due to built-in Wi-Fi. Also, in addition to serving as a highly mobile and responsive director's camera for strong support when shooting on-location and news gathering, the design also meets the needs of advanced amateurs for uncompromising 4K imaging.

*1 For a camcorder with an integrated lens capable of 4K 60p recording
(as of January 6th, 2020, according to a Panasonic research).

*2 35mm camera equivalent.

*3 Up to 4K30p.



Remarkable Optical Performance for Precise Shooting

1/2.5-type (1/2.5-inch) Sensor

Increasing the readout speed has made it possible to handle large-volume 4K data at a fast 60 fps. This suppresses the rolling shutter distortion that often occurs when shooting moving subjects.

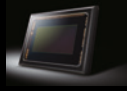

LEICA Dicomar Lens

This high-performance lens has passed the stringent inspection standards of Leica Camera AG for aspects such as resolution and contrast. In addition to rendering sharp, crisp images, it produces the distinctive nuances and subtle shading that Leica lenses are renowned for.



Wide 25mm* and Optical 24x Zoom Lens

The lens covers the range from 25mm wide-angle to 600mm tele with a 24x zoom achieved by a 4-Drive Lens System.

* 35mm camera equivalent.

i.ZOOM 32x (UHD) / 48x (FHD)

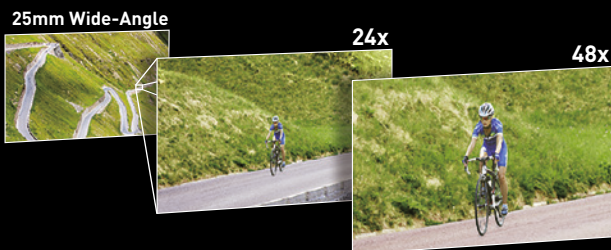

4K High-Precision AF

An image sensor with 60fps readout and a precise focus lens drive enable superior focusing speed, stability and tracking performance for both 4K and FHD. Complex 4K focusing is also automated for comfortable framing of stunning 4K shots.

Face Detection AF/AE Using Colour

Face Detection precisely captures subjects on-site free from out-of-focus problems and insufficient exposure. Also, by adding colour recognition, tracking subjects is improved, without interruption, when the face moves to either side.



5-Axis Hybrid O.I.S. (UHD/FHD)

In both UHD/FHD modes, in addition to Optical Image Stabilization, Electronic Image Stabilization detects and corrects handshake in the 5-axis direction. This provides strong correction under unstable conditions, such as low-angle and high-angle shooting.



Ball O.I.S. System

This system reduces friction on the drive section, achieving delicate correction even for small-amplitude handshake.

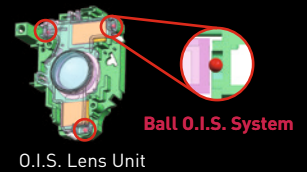

ND Filter

ND filters are built into the lens to suppress the amount of incident light. The filters can be selected (1/4, 1/16, 1/64, or OFF) to match the shooting environment. This is convenient, for example, when you want to shoot at a slow shutter speed in bright daylight. Also, when opening the aperture, you can attain high resolution and a shallow depth of field.



Heat-Dispersing Design

A new ultra-thin fan disperses heat in the camcorder with integrated lens and 4K 60p recording. It is the industry's smallest and lightest unit with low power consumption.



Functions and Designs Supporting Pro Demands

Simultaneous Display on LCD Monitor and EVF

Simultaneous LCD/EVF output constantly displays the LCD monitor image whether the EVF is being viewed or not.

3.5-inch LCD with Touch Operation

The approx. 2,760-k dot LCD monitor has an RGB pixel structure for high legibility in bright light, and an electrostatic touch panel for easy menu selection.

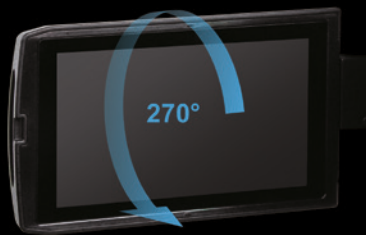

Selfie-shooting Mode

Operational icons are displayed on the touch panel even when the LCD monitor is rotated 180 degrees, so you can shoot while confirming facial expressions and the angle of view.

Tiltable Viewfinder with Eyecup

The 1,560K-dot-equivalent colour viewfinder can be tilted for added convenience. The large eyecup fits either eye comfortably.



Two Manual Rings

Two Manual Rings are provided, one for focusing and the other for zoom or iris operation. The use of the Manual Rings is improved by using different-sized rings in the front and rear, so they can be distinguished by the fingers.



Double SD Card Slot

Two SD card slots are provided. This enables unlimited relay recording by simply changing SD cards, and also allows the use of various recording systems to ensure high recording reliability.



Simultaneous Recording



Identical data is recorded onto cards in both slots in this redundant recording mode.

Background Recording

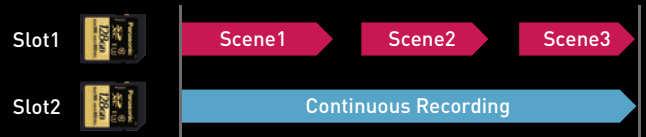

One SD card can be set in Slot 2 to record continuously, and another SD card can be set in Slot 1 to record necessary scenes by turning REC on and off.

Other Recording Functions

- **Pre Rec:** This function constantly caches approximately 10 seconds of video and audio data in AVCHD format and FHD MOV/MP4 format, approximately 5 seconds in UHD MOV/MP4 format or approximately 3 seconds in P2 format, prior to Rec Start, so the data can be recovered in case there is a delay in pressing Rec Start.
- **Interval Rec:** Records intermittently based on a set interval time of 8 patterns, from 1 second to 10 minutes.
- **Time Stamp:** The date and time can be stamped onto recorded images.



High-Quality Recording with Versatile Recording Modes

Venus Engine

The Venus Engine, which contains technologies accumulated with LUMIX, is newly incorporated in these camcorders. This enables 4:2:2 10-bit internal recording with maximum 29.97p in UHD, and maximum 59.94p in FHD.



4:2:2 10-bit Internal Recording / HDMI Output

Records a 4:2:2 10-bit colour profile of up to LongGOP UHD 29.97p/25p (150 Mbps), or FHD 59.94p/50p (100 Mbps) with SD cards. When set for

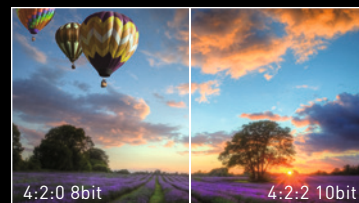

10-bit recording, the camcorder delivers 4K 60p 4:2:2 10-bit HDMI output, enabling high image quality capture with an external recorder.

HEVC 4:2:0 10-bit

Equipped with a new, highly-efficient HEVC codec for video recording. High-bit rate recording with LongGOP 200M (59.94p, 4:2:0 10-bit, MOV) and LongGOP 100M (59.94p, 4:2:0 10-bit, MP4) is possible.

MOV File System for Excellent File Management

The same file system as that used with the AG-CX350 Professional Handheld Camcorder will automatically create filenames 20 characters in length for easy control of clips. Conventional AVCHD acquisition is also supported.

Multi-Formats Supported

Versatile formats and bit rates are available. In addition to easy-to-edit MOV and MP4, 720p AVCHD 8-Mbps (PM) mode is included.

	Recording Mode	Recording Size	Colour Sampling	Bit Depth	Bit Rate	Frame Rate	Sound	
MOV	UHD	422 LongGOP 150M	3840x2160	4:2:2	10 bit	150M VBR	29.97p/ 25p / 23.98p	24bit LPCM
		HEVC LongGOP 200M	3840x2160	4:2:0	10 bit	200M VBR	59.94p / 50p	24bit LPCM
		HEVC LongGOP 150M	3840x2160	4:2:0	10 bit	150M VBR	29.97p/ 25p / 23.98p	24bit LPCM
		420 LongGOP 150M	3840x2160	4:2:0	8 bit	150M VBR	59.94p / 50p	24bit LPCM
		420 LongGOP 100M	3840x2160	4:2:0	8 bit	100M VBR	29.97p/ 25p / 23.98p	24bit LPCM
	FHD	422 ALL-I 200M	1920x1080	4:2:2	10 bit	200M VBR	59.94p / 50p	24bit LPCM
		422 ALL-I 100M	1920x1080	4:2:2	10 bit	100M VBR	29.97p/ 25p / 23.98p / 59.94i / 50i	24bit LPCM
		422 LongGOP 100M	1920x1080	4:2:2	10 bit	100M VBR	59.94p / 50p	24bit LPCM
422 LongGOP 50M		1920x1080	4:2:2	10 bit	50M VBR	29.97p/ 25p / 23.98p / 59.94i / 50i	24bit LPCM	
MP4	UHD	HEVC LongGOP 100M	3840x2160	4:2:0	10 bit	100M VBR	59.94p / 50p	16bit AAC
		HEVC LongGOP 72M	3840x2160	4:2:0	10 bit	72M VBR	29.97p/ 25p / 23.98p	16bit AAC
		420 LongGOP 72M	3840x2160	4:2:0	8 bit	72M VBR	29.97p/ 25p / 23.98p	16bit AAC
	FHD	420 LongGOP 50M	1920x1080	4:2:0	8 bit	50M VBR	59.94p / 50p / 23.98p	16bit AAC
AVCHD	FHD	PS	1920x1080	4:2:0	8 bit	25M VBR	59.94p / 50p	Dolby Audio
		PH	1920x1080	4:2:0	8 bit	21M VBR	23.98p / 59.94i / 50i	Dolby Audio
		HA	1920x1080	4:2:0	8 bit	17M VBR	59.94i / 50i	Dolby Audio
	HD	PM	1280x720	4:2:0	8 bit	8M VBR	59.94p / 50p	Dolby Audio
P2	FHD	AVC-LongG50	1920x1080	4:2:2	10 bit	50M VBR	59.94i / 50.00i	24bit LPCM
		AVC-LongG25	1920x1080	4:2:2	10 bit	50M VBR	59.94p / 50.00p	24bit LPCM
		AVC-LongG25	1920x1080	4:2:2	10 bit	25M VBR	59.94i / 50.00i	24bit LPCM
	HD	AVC-LongG50	1280x720	4:2:2	10 bit	50M VBR	59.94p / 50.00p	24bit LPCM
		AVC-LongG25	1280x720	4:2:2	10 bit	25M VBR	59.94p / 50.00p	24bit LPCM

Super Slow-Motion Recording

In FHD mode, slow-motion recording at 120 fps [for 59.94 Hz]/100 fps [for 50 Hz] is possible. 10-bit recording is supported, and full-frame images with the image area uncropped are obtained even at high frame rates. Auto focus can also be used even during super slow-motion recording.



IR (Infrared) Shooting in Dark Places

The IR Cut Filter can be turned ON/OFF (allocated on the User button). When the filter is turned OFF, commercially available IR lights* can be used for shooting in dark places.



* Recommended: 850-nm wavelength light.

16-Axis Independent Colour Correction Function

This function provides an independent effect to each of the 16 phases of video images. It enables colour matching of multiple cameras under the same lighting conditions as well as creative image rendering.

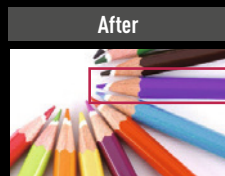
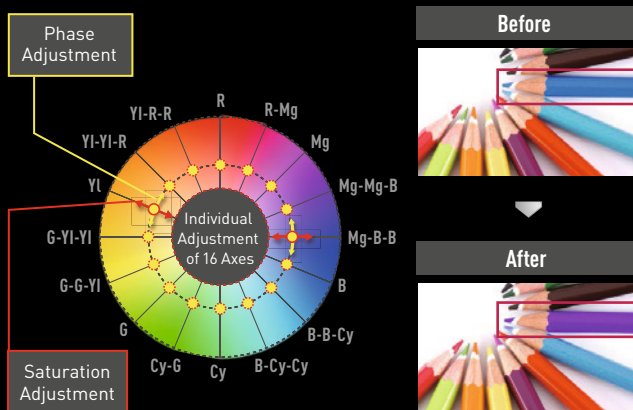

Soft Skin

Makes skin colours appear softly and beautifully. Especially effective when recording the person up close.

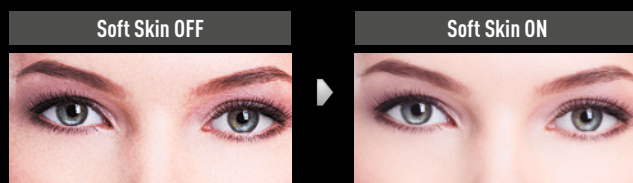

Master Detail

Adjusts the overall degree of contour enhancement.



8-Mode Gamma

Gamma can be selected from eight modes, including two Cine-Like modes developed based on VariCam know-how. Desired gradation can be achieved to suit specific video production needs.

Scene Files

Six files preset with picture quality settings are provided as Scene Files (Standard, Shooting under fluorescent lights, Spark, STILL-LIKE, CINE-LIKE contrast, and CINE-LIKE dynamic range). You can change any of the settings as desired and store one set as a Custom File in the camcorder.

Scene File Setting Items

- Master Detail • Detail Coring • V Detail Level • RB Gain Control Setting • Chroma Level • Chroma Phase • Matrix • Colour Correction Setting • Skin Tone Detail • Master Pedestal • Gamma Mode • Black Gamma • Knee Mode • DRS • DRS Effect • NR Control • AE Level • AE Level Effect

Save/Restore Camera Setting

This function lets you save your camera's setup information to a file on an SD memory card, which is helpful when you need the same settings for later use, or when shooting with multiple cameras and users.

LCD/EVF Displays That Assist Shooting

- Waveform Monitor Display • Vector Scope
- Zebra Pattern • Luminance Level Adjustment
- Level Gauge

Professional Assist Functions

- Flash Band Correction • Shockless Auto White Balance
- Selectable matrix tables including CINE-LIKE mode
- V detail, detail coring
- Chroma level, chroma phase, colour temperature, master pedestal
- Knee point setting

Versatile Network Functions Expand the User's Workflow

Built-in Wi-Fi

A 2.4-GHz Wi-Fi module is built-in, so there is no need to purchase a separate wireless LAN module. Wi-Fi connection is possible using only the main unit.



Wireless Control from a Tablet or Smartphone

Use wireless remote control with a tablet/smartphone app HC ROP (downloadable for free from the App Store or Google Play).^{*1} In addition to zoom and focus lens control, the app enables remote control of various other functions, including camera setting, picture quality adjustment, REC start/stop and menu setting. What's more, the app can be used to select the camera to control from up to eight cameras.^{*2}



^{*1} iPad/iPhone: iOS 11 or later and iPadOS are supported. Android devices: Android 6.0 or later are supported.

^{*2} The app does not support simultaneous/synchronous control of multiple cameras. Camera switching takes several seconds.

Wired Remote

Equipped with a REMOTE terminal (2.5-mm super mini jack) for remote operation of focus, zoom, REC start/stop, etc.

* A wired remote controller (commercially available) is required.

FHD Live Streaming

RTSP/RTMP/RTMPS-compatible FHD streaming enables direct connection and distribution of relays for concerts, sports events, and news flashes to Facebook, YouTube, etc. While streaming, recording (with modes below FHD) onto SD cards in the camera is also possible.



3G-SDI Output

The 3G-SDI output terminal (BNC connector, 5CFV) can be used to transmit FHD 1080/60p, 1080/50p signals through a coaxial cable over a distance of up to 100 m. Panasonic recorders equipped with SDI input can be linked to the Rec Start/Stop function of the AG-CX10.



Workflow Examples

Live Video Streaming System

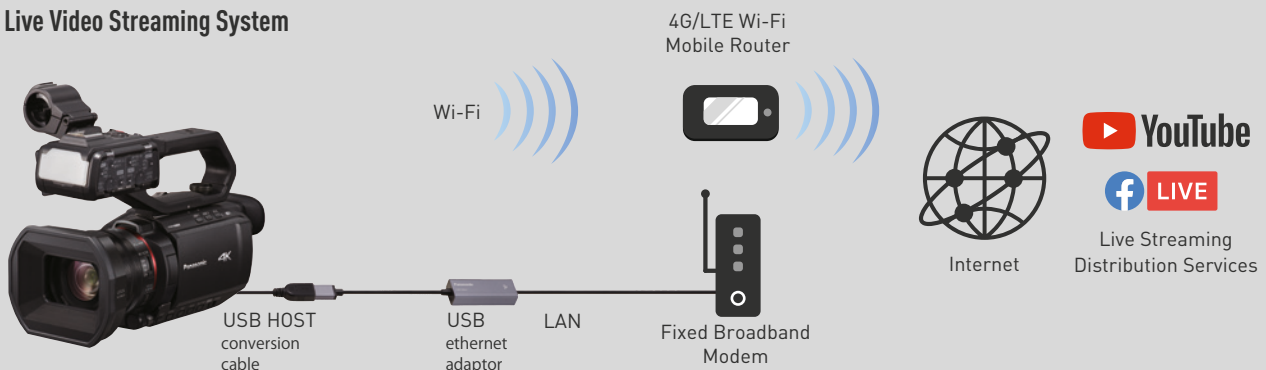

Functions and Designs Supporting Pro Camera Work

Built-in LED Video Light

The video light is extremely bright (70 lx at 1 metre) for reliable shooting in dimly lit places. The Dimming Dial on the handle can be used to easily dim the brightness from 30%-100%.



Cable Holding Clamp

A cable clamp on the hand belt prevents the cable from catching on objects when shooting, or pulling out a terminal to interrupt live streaming.



24-bit High Resolution Linear PCM Audio Recording

+48V Phantom Power Supply/MIC/LINE Selectable XLR Audio Input with Manual Volume is equipped for each of 2 channels. Also supports 24-bit high-resolution PCM audio recording with a professional mic.



Detachable Handle Unit

Easily detachable and equipped with a REC Button, Zoom Lever, 2-channel XLR Audio Input, LED Light, etc. Capable of full-scale audio recording with a professional mic.



User Buttons

38 functions can be allocated to the User Buttons. There are a total of 12 User Buttons: five on the body, and seven on the LCD Touch Panel. The O.I.S. and AE LEVEL buttons can also be used as User Buttons.

Features

P2 MXF File Formats Supported

Along with MOV, MP4, and AVCHD file formats, the advanced editing system for broadcasters, P2 MXF, is supported* with AVC-Intra/AVC-LongG codecs.

* AVC-Intra100/50 codec support is planned for the future. microP2 cards are required for acquisition in all P2 formats.

Easy IP Connection: NDI|HX Capable

Transmits data and camera control via IP connection, without a converter. Linking the AV-HLC100 and HN/UN Series enables a live streaming system.

*Recording, streaming and 4K output are not available when using NDI|HX mode. Purchasing of an Activation Key is required to use the NDI|HX function. For details, refer to the NewTek website.

Ethernet (Conversion Adaptor Included)

Wired Internet connection is possible by simply providing a LAN cable. This enables stable live streaming even in environments with unstable Wi-Fi.

* The supplied USB HOST conversion cable and USB ethernet adaptor are necessary for the connection.

	AG-CX10
Detachable Handle Unit	●
XLR Input x 2	●
LED Light	●
3G SDI-Out	●
P2 MXF	●
microP2 card Support	●
NDI HX Compatible	●
Ethernet*	●
USB Host Conversion Cable Included	●
USB Ethernet Adaptor Included	●

* The supplied USB HOST conversion cable and USB ethernet adaptor are necessary for the connection.

AG-CX10 Main Parts and Controls

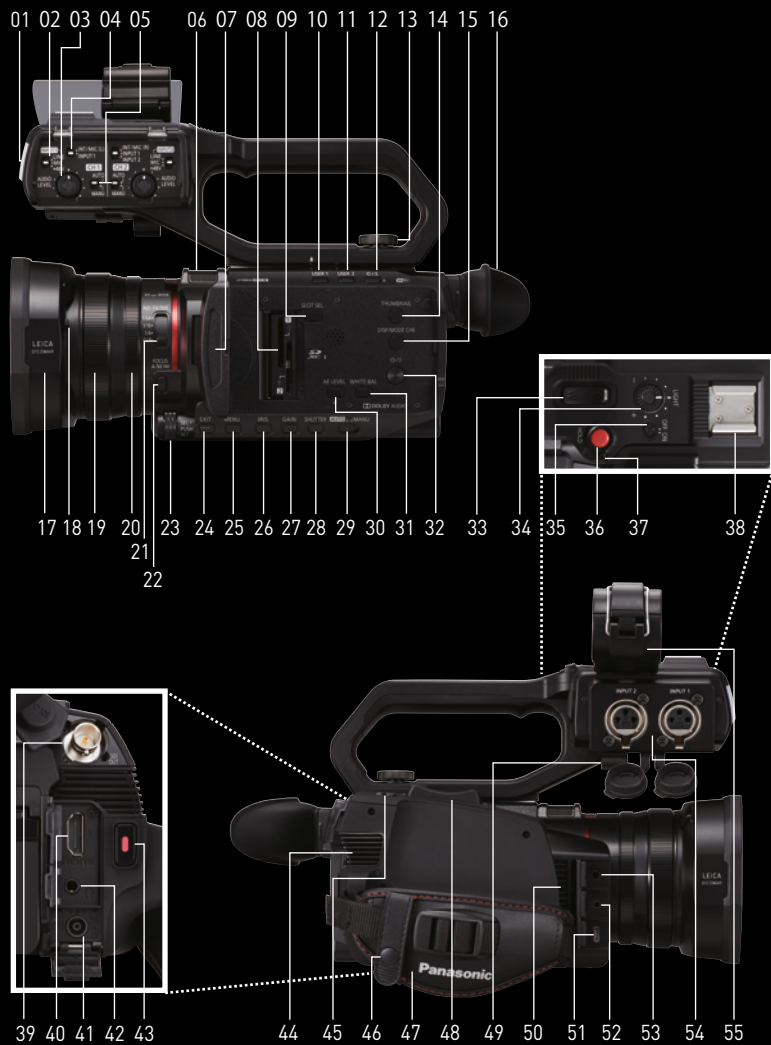

- 01. Built-in LED Light
- 02. Line/Mic/+48V Switch
- 03. Audio Level Dial
- 04. Built-in Mic or MIC Terminal/
Input Terminal Switch
- 05. Auto/Manual Audio Level Switch
- 06. Built-in Stereo Microphone
- 07. LCD Monitor
- 08. SD Card Slot x 2
- 09. Slot Select Button
- 10. User 1 Button
- 11. User 2 Button
- 12. O.I.S./User 3 Button
- 13. Handle Unit Mounting Screw
- 14. Thumbnail Button
- 15. Display/Mode Check Button
- 16. Eye Cup
- 17. Lens Hood
- 18. Lens Cover Open/Close Switch
- 19. Focus Ring
- 20. Zoom/Iris/Iris or AE Level Ring
- 21. ND Filter Switch
- 22. Focus A/M/∞ Button
- 23. Multi-function Dial
- 24. Exit Button
- 25. Menu Button
- 26. Iris Button
- 27. Gain Button
- 28. Shutter Button
- 29. Auto/Manual Switch
- 30. AE Level/User 4 Button
- 31. White Balance Button
- 32. Power Button
- 33. Zoom Lever
- 34. Light Dimmer Dial
- 35. Light Switch
- 36. REC Button
- 37. Hold Lever
- 38. Accessory Shoe
- 39. SDI OUT
- 40. HDMI Terminal
- 41. DC IN Terminal
- 42. Headphones Terminal
- 43. REC Button
- 44. Fan Inlet
- 45. User 5 Button
- 46. Cable Holding Clamp
- 47. Grip Belt
- 48. Zoom Lever
- 49. Mic Cable Clamp
- 50. Fan Outlet
- 51. USB Terminal
- 52. REMOTE Terminal
- 53. Mic Terminal
- 54. XLR Audio Input x 2
- 55. Microphone Holder

Optional Accessories

* Some accessories are not available in some countries.

Battery Pack		Battery Charger		LED Video Light	XLR Microphone
VW-VBD58	AG-VBR59	AG-B23	AG-BRD50	VW-LED1	AG-MC200G
Stereo Microphone		SD Memory Card		micro P2 Card	
VW-VMS10		RP-SDUT64GAK	RP-SDUT128AK	AJ-P2M064BG	

- Weight and dimensions shown are approximate. • Design, functions, and specifications are subject to change without notice.
- All monitor and TV pictures are simulated. • 1 GB = 1 billion bytes. Usable capacity will be less.
- Panasonic will also in no way be liable for any losses of data caused by these products.
- SDXC Logo is a trademark. • SDHC Logo is a trademark. • SD Logo is a trademark.
- Leica is a registered trademark of Leica Microsystems IR GmbH. • Dicomar is a registered trademark of Leica Camera AG.
- The Wi-Fi CERTIFIED Logo is a certification mark of the Wi-Fi Alliance.
- The terms HDMI and HDMI High-Definition Multimedia Interface, and the HDMI Logo are trademarks or registered trademarks of HDMI Licensing, LLC in the United States and other countries.
- Quick Time is a trademark of Apple, Inc., registered in the U.S. and other countries.
- Android, Google Play, and YouTube are trademarks of Google, Inc.
- App Store is a service mark of Apple Inc.
- Facebook™ and the Facebook logo are registered trademarks or trademarks of Facebook, Inc.
- iOS is a trademark or registered trademark of Cisco in the U.S. and other countries and is used under license.
- Other names of systems and products mentioned in this brochure are generally the registered trademarks or trademarks of the manufacturers who developed the system or product concerned.
- All other company and product names are trademarks of their respective corporations.

AG-CX10 Specifications

SENSOR SECTION

Image Sensor	1/2.5-type MOS Sensor (For Europe) 1/2.5-inch MOS Sensor (For North America / Asia)
Effective Pixels	8.29 megapixels

LENS SECTION

F Value	F1.8 — 4.0
Optical Zoom	24x
Focal Length	4.12 — 98.9 mm (35 mm Film Camera Equivalent: 25.0 — 600.0 mm)
Filter Diameter	62 mm
Lens Brand	Leica Dicomar Lens

CAMERA SECTION

Minimum Illumination	1.5 lx (F1.8, Super Gain +, 1/30)	
Focus	Auto / Manual	
i.Zoom OFF	24x	
i.Zoom ON	Max. 48x (UHD 32x)	
Digital Zoom	2x / 5x / 10x	
ND Filter	1/4, 1/16, 1/64, OFF	
IR Filter	Incorporates the ON/OFF control function	
White Balance	Auto / ATW LOCK / 3200K / 5600K / VAR (2000K—15000K) / Ach Fixed / Bch Fixed	
Shutter Speed	59.94 Hz mode	59.94i/59.94p: 1/60, 1/100, 1/120, 1/180, 1/250, 1/350, 1/500, 1/750, 1/1000, 1/1500, 1/2000, 1/3000, 1/4000, 1/8000 sec 29.97p: 1/30, 1/50, 1/60, 1/100, 1/120, 1/180, 1/250, 1/350, 1/500, 1/750, 1/1000, 1/1500, 1/2000, 1/3000, 1/4000, 1/8000 sec 23.98p: 1/24, 1/48, 1/50, 1/60, 1/100, 1/120, 1/180, 1/250, 1/350, 1/500, 1/750, 1/1000, 1/1500, 1/2000, 1/3000, 1/4000, 1/8000 sec
	50.00 Hz mode	50i/50p: 1/50, 1/60, 1/100, 1/125, 1/180, 1/250, 1/350, 1/500, 1/750, 1/1000, 1/1500, 1/2000, 1/3000, 1/4000, 1/8000 sec 25p: 1/25, 1/50, 1/60, 1/100, 1/125, 1/180, 1/250, 1/350, 1/500, 1/750, 1/1000, 1/1500, 1/2000, 1/3000, 1/4000, 1/8000 sec
Slow Shutter Speed	59.94 Hz mode	59.94i/59.94p: 1/8, 1/15, 1/30 sec 29.97p: 1/8, 1/15 sec 23.98p: 1/6, 1/12 sec
	50.00 Hz mode	50i/50p: 1/6, 1/12, 1/25 sec 25p: 1/6, 1/12 sec
Super Slow Recording Frame Rate	59.94 Hz: FHD 120 fps (1/2 speed at 60p, 1/4 speed at 30p, 1/5 speed at 24p) 50.00 Hz: FHD 100 fps (1/2 speed at 50p, 1/4 speed at 25p)	
Iris	Auto / Manual	
Image Stabilizer	Ball O.I.S., 5-Axis HYBRID O.I.S. (UHD/FHD)	

RECORDING SECTION

Recording Media	SDHC/SDXC Memory Card, microP2 card (A series, B series)
Recording Format	MOV, MP4, AVCHD, P2
Video Compression Method	MOV/MP4: H.264/MPEG-4 AVC High Profile, H.265/MPEG-H HEVC Main10 Profile AVCHD: H.264/MPEG-4 AVC High Profile P2: AVC-LongG 50i/AVC-LongG25:MPEG-4 AVC/H.264 High Profile
Audio Compression Method	MOV / P2: LPCM (24bit 2ch) MP4: AAC (16bit 2ch) AVCHD: Dolby Audio (16bit 2ch)
System Frequency	59.94 Hz / 50.00 Hz

LIVE STREAMING

Video Compression Format	H.264/MPEG-4 AVC Main Profile, High Profile
Video Resolution	1920 x 1080 (FHD), 1280 x 720 (HD), 640 x 360, 320 x 180
Streaming Method	Unicast, Multicast
Frame Rate	System frequency = 59.94 Hz: 30 fps, 60 fps System frequency = 50.00 Hz: 25 fps, 50 fps
Bit Rate	24 Mbps, 20 Mbps, 16 Mbps, 14 Mbps, 8 Mbps, 6 Mbps, 4 Mbps, 3 Mbps, 2 Mbps, 1.5 Mbps, 1 Mbps, 0.7 Mbps, 0.5 Mbps
Audio Compression Format	AAC-LC, 48 kHz/16 bit, 2ch
Network Protocol	RTSP/RTMP/RTMPS

STILL IMAGE SECTION

Recording Format	JPEG (DCF/Exif2.2)
Recording Image Size*1	Video Playback Mode: 3840 x 2160 (16:9), 1920 x 1080 (16:9), 1280 x 720 (16:9)

GENERAL SECTION

Power Supply	7.28V (Battery) / 12V (AC Adaptor)
Power Consumption	15.5W (LCD Monitor)
Dimensions (W x H x D)	Approx. 129 x 159 x 257 mm (5.08 x 6.26 x 10.1 inch)
Weight	Body: approx. 0.9kg (1.98 lb)*2 Shooting: approx. 1.5kg (3.31 lb)*3
LCD Monitor	8.88 cm (3.5-inch) Wide LCD monitor (About 2,760,000 dots) (For Europe) 3.5-inch Wide LCD monitor (About 2,760,000 dots) (For North America / Asia)
Viewfinder	0.61 cm (0.24-inch) Wide EVF (About 1,560,000 dots) (For Europe) 0.24-inch Wide EVF (About 1,560,000 dots) (For North America / Asia)
Manual Ring	Focus / Zoom or Iris
Accessory Shoe	Yes
LED Video Light	Average Illumination: Approx. 70 lx (1.0m) Irradiation Angle: Approx. 30° Colour Temperature: Approx. 4600K

INTERFACE SECTION

Video	SDI OUT	BNC x 1, 0.8V(p-p), 75Ω, 3G/1.5G HD-SDI supported Output format: 1080/59.94p LEVEL-A/50.00p LEVEL-A, 1080/29.97PsF/25.00PsF/23.98PsF, 1080/59.94i/50.00i, 720/59.94p/50.00p
	HDMI	Type A x 1 (VIERA Link not supported) Output format: 2160/59.94p/50.00p/29.97p/25.00p/23.98p, 1080/59.94p/50.00p/29.97p/25.00p/23.98p/59.94i/50.00i, 720/59.94p/50.00p, 480/59.94p, 576/50.00p
Audio Input	Built-in Microphone	Stereo microphone
	Microphone Input	3.5mm stereo mini jack x 1
	XLR Input	XLR (3 pins) x 2, Input high impedance, LINE/MIC/MIC+48 V (switchable SW) LINE: +4dBu/0dBu (switchable menu) MIC: -40dBu/-50dBu/-60dBu (switchable menu)
Audio Output	SDI	2 ch (LPCM) Gain: 0dB/-6dB/-8dB
	HDMI	2 ch (LPCM)
	Headphone	3.5 mm diameter stereo mini jack x 1
	Speaker	15 mm diameter, round x 1
Other Input/Output	Camera Remote	2.5mm super mini jack x 1
	USB 2.0 HOST	Micro-AB connector, 5-pin, only USB LAN conversion supported
	USB 2.0 DEVICE	Micro-AB connector, 5-pin, mass storage function (read only)
	DC IN	DC 12V (11.4V — 12.6V) EIAJ Type4

Wi-Fi

Standard	IEEE 802.11b/g/n
Frequency	2.4 GHz band

STANDARD ACCESSORY

AC Adaptor	Yes
AC Cable	Yes
Rechargeable Battery Pack	5,900mAh
Handle Unit	Detachable
USB HOST Conversion Cable	Yes
USB Ethernet Adaptor	VW-UEA1
Microphone Holder	Yes
Microphone Holder Screws	Yes
Eye Cup	Yes
Lens Hood	Yes

*1 Only images cut from video in video playback mode are supported.

*2 Body only, excluding handle, lens hood, battery, and accessories

*3 Including handle, lens hood, battery, and eyecup

WARRANTY

3 years European standard Warranty - 5 day guaranteed turn around.

Optional 2 years European Warranty extension available (Part number: AG-CX10E5YWV).