

# JVC

HD/SD Memory Card Camcorder

## GY-HM890

## GY-HM850

*Beyond Newsworthy*

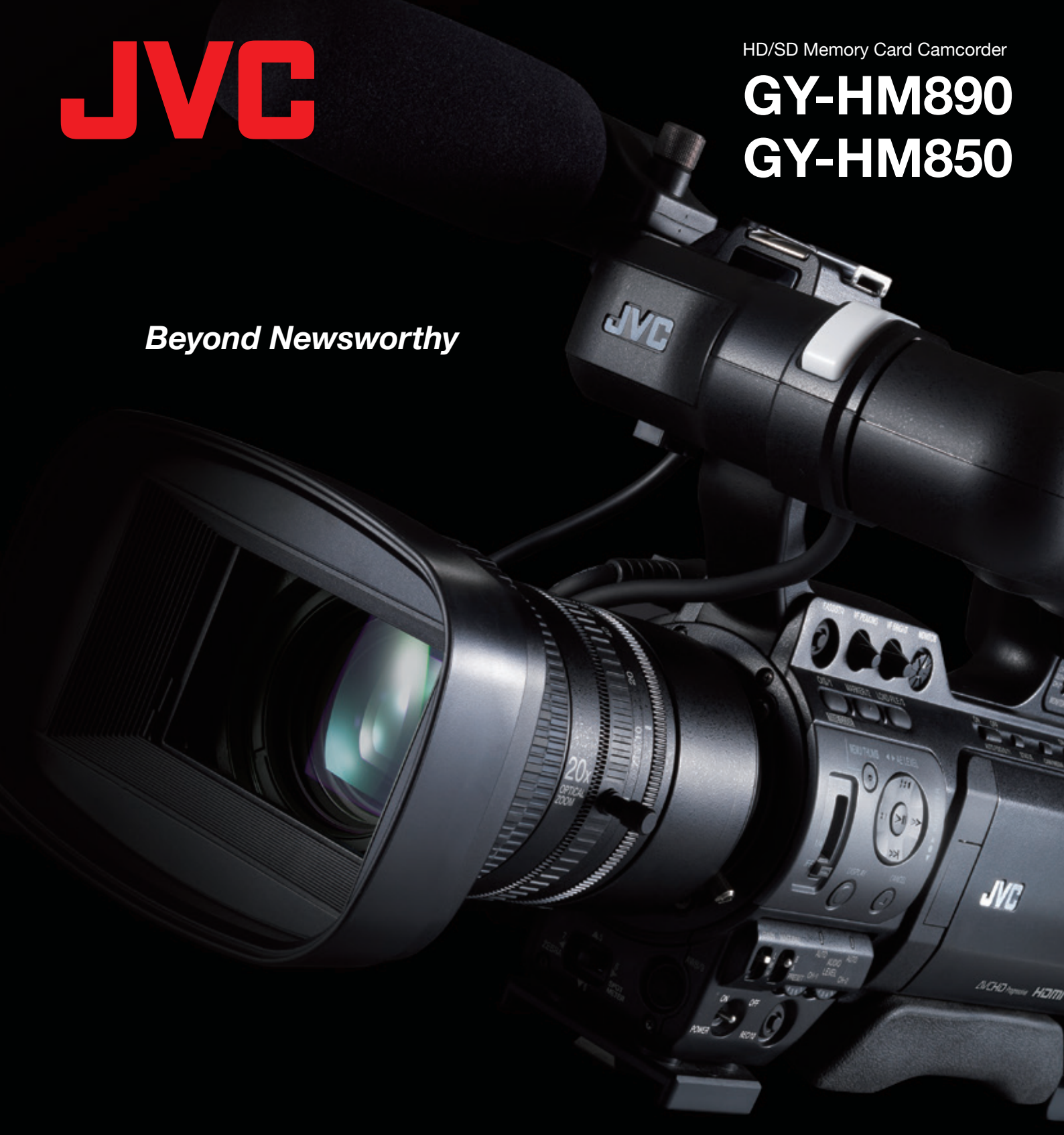

# ProHD

**HDMI**<sup>®</sup>  
HIGH-DEFINITION MULTIMEDIA INTERFACE

**MOV**  
QuickTime<sup>™</sup>

**MP4**

**MXF**

**ftp**

**GPS**

**SD**  
CLASS<sup>®</sup>

**SD**  
CLASS<sup>®</sup>

**SD**  
XC<sup>™</sup>

**AVCHD**  
Progressive

# Quality and Mobility when Every Minute Counts

Rush to the scene with the ProHD GY-HM850/HM890 compact shoulder camcorder and deliver the news faster than ever. Wirelessly backhaul via FTP or stream LIVE over a Wi-Fi or 4G-LTE/3G network. Record on cost-effective SDHC/SDXC cards, in HD or SD, including simultaneous recording in two different resolutions. You can even stream and record at the same time. Save time and money getting breaking news on the air with the GY-HM850 or studio-friendly GY-HM890, and stay on top of the action.



# QUALITY



## Fujinon 20x Optical Zoom Lens with AF/OIS

Newly developed Fujinon 20x zoom lens with built-in AF/OIS delivers precision performance with simplified, comfortable operation. ...P6

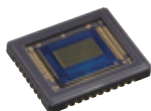

## Full HD 1/3-inch CMOS Sensors

Three CMOS sensors offer an excellent sensitivity of F11 (60Hz) / F12 (50Hz) and a remarkable S/N ratio for vivid colour reproduction. ...P6



## Extreme-High Quality HD Recording

Record in XHQ H.264 50Mbps for the highest quality, as well as various other modes to support a wide range of native workflows. ...P6



## SDHC/SDXC Memory Card Recording

Dual card slots allow continuous shooting over multiple SDHC/SDXC cards for "unlimited" recording capability using cost-effective media for low running cost. ...P7





Picture shows the GY-HM890 attached with an optional Wi-Fi adapter.

# NETWORK

## First On-Air, First On-Line with Network Connectivity

While recording content on SDHC/SDXC media, the GY-HM850/HM890 also has built-in wireless network clients to enable quick access. Simply plug in a USB modem or Wi-Fi adapter to enjoy these benefits:

- Easily connect to Wi-Fi or 4G-LTE/3G network
- LIVE streaming backhaul in real-time
- Send footage quickly via FTP server
- Remote functions via network



Photo courtesy of WSET, Virginia



Photo courtesy of Ferro Productions, New York



Photo courtesy of Church of Champions, Houston

# STUDIO SYSTEM

## System Expandability Maximises Your Value

The GY-HM890 can be upgraded with various options making it a valuable part of your studio system by virtue of:

- Compatible with studio and ENG systems
- Fibre Optic and Multicore system solutions available

# Cost-Effectively Ready for A Wide Range of Applications

## ENG

HD/SD ENG System

### Superior Mobility and Recording Capabilities

Record in today's essential Full HD, or SD for legacy applications, with native support of MOV compatible with Apple Final Cut Pro, MP4 and MXF formats to accommodate a wide range of workflows. On-board dual SDHC/SDXC card slots ensure that you have virtually "unlimited" recording capacity in the field.



Photo courtesy of KTUL, Tulsa, Oklahoma

## ENG

Networked LIVE ENG System

### Network Connectivity for Extreme Backhaul Flexibility

Win the race to get breaking news on the air. LIVE streaming and FTP backhaul transfer over Wi-Fi or 4G-LTE/3G networks give you the edge. Since FTP and LIVE streaming clients are built into the camera, all you do is plug-in a USB network adapter and you're ready for LIVE delivery.



Photo courtesy of Carnival Cruise Lines



**GY-HM850/HM890**  
(Picture shows the GY-HM890)



**GY-HM850/HM890**  
(Picture shows the GY-HM890 attached with an optional Wi-Fi adapter)

- Native File Recording for Direct-To-Edit capability
- Compact Shoulder Camcorder
- USB Port (supports commercially available network adapters)



# EFP

EFP System

## Expansion Capability for Multi-camera Recording

Image capture based on multi-camera operation is possible. The GY-HM890's multi-pin interface connects to optional modules to create a seamless multicore or fibre optic EFP system that can expand your field production over a greater distance.



Photo courtesy of Riverside Government Television, California



Genlock In  
TC In/Out

GY-HM890

### KA-M790G

#### Multicore Studio Interface Unit

Intercom, call, camera control, video/genlock, tally and other signals interface via 68-pin multi-connector is possible via 26-pin RM connector on back

### KA-F790G

#### Fibre Optic Studio Interface Unit

### RM-HP790

#### Camera Remote Control Unit

### RM-LP25U

#### Remote Control Unit

# STUDIO

Studio System

## Flexible Configuration for Studio-based Program Production

Create a highly robust studio camera setup by attaching the dedicated sled to your studio pedestal, complemented by JVC's high-resolution VF-HP790G HD Viewfinder and teleprompter. To lower integration costs, existing 26-pin control cables can be used to connect studio essentials such as remote control units.



Photo courtesy of Loyola Studio, Maryland



**VF-HP790G**  
8.4" LCD Studio Viewfinder  
XGA LCD studio viewfinder with External SDI input

GY-HM890  
with optional lens

### KA-790G

#### Studio Sled Support

To accommodate studio viewfinder, teleprompter and pedestal

### FS-790

#### Optical fibre system

The KA-F790's custom designed camera back transceiver module FS-790 attaches directly to the GY-HM890 body using a 68-pin multi-connector and enables broadcasters to leverage the GY-HM890's full studio functionality in the field. It connects the camera via SMPTE hybrid (powered) or tactical (unpowered) fibre optic cable to the RM-FP790 base station.



## Innovative Technologies to Maximise Usability and Versatility

### Newly-developed 20x Fujinon Auto Focus Zoom Lens with Manual Functions

The GY-HM850/HM890 is equipped with a newly-developed Fujinon wide-angle 20x zoom lens offering one of the highest magnifications in the industry. For superior low-light performance and assured brightness at the tele end, the lens offers F1.6-3.0, a focal range of 29mm – 580mm (35mm equivalent) and includes servo zoom, along with manual focus and iris rings. Optical image stabiliser and chromatic aberration correction are also built into this interchangeable 1/3-inch bayonet mount lens.



### High Performance Full HD 1/3-inch CMOS Sensors

At the heart of the GY-HM850/HM890 are three 1/3-inch 2.07 effective-megapixel CMOS sensors, each capable of capturing full HD 1920 x 1080 resolution images. Featuring 12bit processing, an excellent sensitivity of F11 (60Hz) / F12 (50Hz) and a remarkable signal-to-noise ratio, the devices provide superior precision and colour reproduction with minimal aberration. For improved CMOS sensor performance, flash-band compensation is also supported.

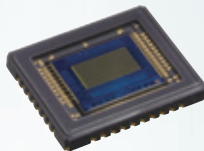

### MPEG-2/AVCHD Recording and Dual Codec

The GY-HM850/HM890 supports both the popular MPEG-2 Long GOP 35/25/19Mbps format widely used by television broadcasters, and the highly efficient AVCHD progressive format, which provides compatibility with a wide range of affordable NLE systems. This means that professionals have unprecedented flexibility to meet production standards through a wide range of workflows. The dual codec also enables the GY-HM850/HM890 to offer simultaneous HD/SD or HD/Web recording, producing full HD files on one memory card while creating smaller, Web-friendly files on the other. Also supported is the MPEG-4/AVC H.264 8Mbps SD format.

### FALCONBRID™ Image Processing Engine

FALCONBRID™ is JVC's high-speed processor for advanced video applications. Delivering tremendous processing power, the on-board FALCONBRID™ engine processes large amounts of video data at exceptional speeds. Together with this technology, superior image quality has been realised with 2D DNR processing and dynamic range compensation circuitry.



**FALCONBRID™**

	Mode (Bit rate)	Resolution	File format	Frame rate						
				Progressive			Interface			
				60p	50p	30p	25p	24p	60i	50i
MPEG-2	HQ (35Mbps)	1920x1080	MOV/MP4/MXF		•	•	•	•	•	•
	HQ (35Mbps)	1440x1080	MOV/MP4/MXF						•	•
	HQ (35Mbps)	1280x720	MOV/MP4	•	•	•	•	•		
	SP (25Mbps)	1440x1080	MOV/MP4/MXF						•	•
	SP (19Mbps)	1280x720	MOV/MP4	•	•					
AVCHD	Progressive (28Mbps)	1920x1080	MTS	•	•					
	HQ (24Mbps)	1920x1080	MTS						•	•
	SP (17Mbps)	1920x1080	MTS						•	•
	LP (9Mbps)	1440x1080	MTS						•	•
	EP (5Mbps)	1440x1080	MTS						•	•
MPEG-4/AVC H.264	XHQ (50Mbps)	1920x1080	MOV	•	•	•	•	•	•	•
	UHQ (35Mbps)	1920x1080	MOV			•	•	•	•	•
	SD (8Mbps)	720x480	MOV						• <sup>1</sup>	• <sup>2</sup>
	WEB HQ (3Mbps)	960x540	MOV			•	•	•		
	WEB LP (1Mbps)	480x270	MOV			•	•	•		

<sup>1</sup>: U only <sup>2</sup>: E only



## Virtually Lossless H.264 50Mbps Recording

The GY-HM850/HM890 is also equipped with the H.264 Extreme-High Quality (XHQ) 50Mbps (MOV) recording mode used in HD SLRs. MPEG-4 AVC/H.264 offers approximately twice the compression efficiency of conventional codecs, and offers superior motion prediction, so even at the same bit rate it provides a smooth and detailed picture with virtually no block noise even when recording rapid action sequences. Added to this, the 50Mbps bit rate is high enough to support full 1920 x 1080 encoding in 50p or 50i, resulting in stunningly detailed HD images.

**H.264  
50Mbps**



H.264 XHQ 50Mbps



MPEG-2 50Mbps

## Multiple File Formats for Native Workflows

Record HD or SD footage directly in ready-to-edit QuickTime™ MOV files, the native file format of Apple's Final Cut Pro™. Native file recording ensures your footage is ready to edit the moment it's shot, resulting in a more efficient workflow with lossless quality. For direct editing in other major NLE systems such as Avid Media Composer, Adobe Premiere and Grass Valley Edius Pro, it is also possible to record XDCAM EX™ compatible MP4 files for a likewise seamless native workflow.

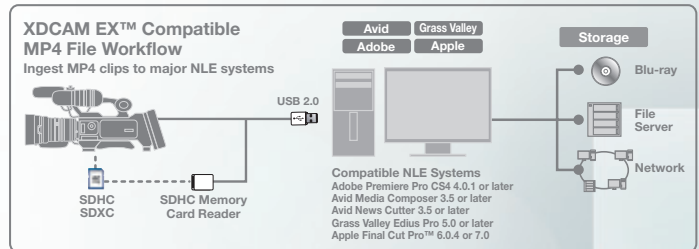
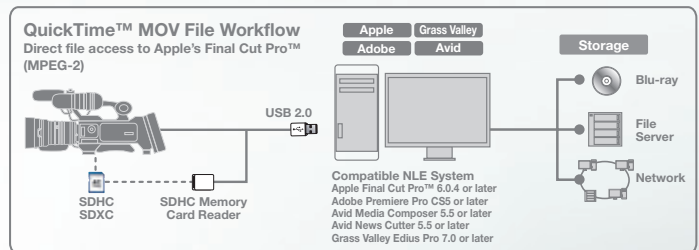

## Dual SDHC/SDXC Card Slots for Maximum Versatility

Dual SDHC/SDXC card slots enable simultaneous recording and relay recording with reliable and cost-effective media. In relay recording mode, you can shoot continuously over multiple cards. When one card is full, the camcorder switches seamlessly and automatically to the other card. And because cards are hot swappable, there is in effect no limit to the continuous shooting time in any mode. It is possible to start editing footage from one card while still shooting to the other.

With simultaneous recording, you can easily create backup or duplicate files as you shoot, either for a client copy or simply for peace of mind. Additionally, while the Rec trigger is used to pause and unpause recording on one card, the other card can act as a continuous backup that overrides the pause function.\*

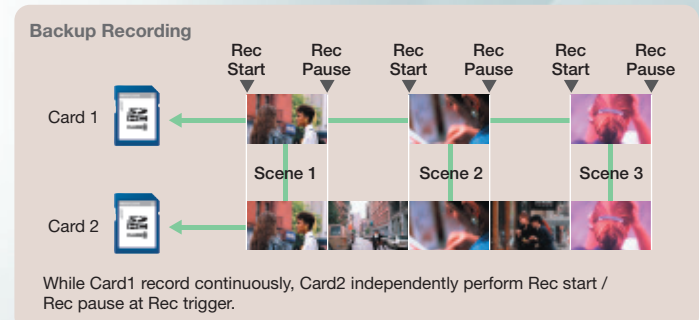
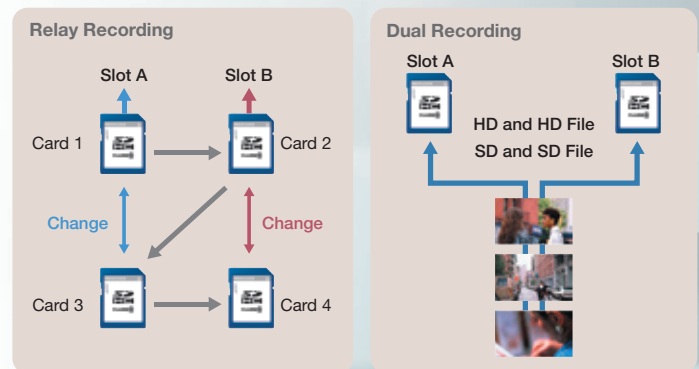

\*During simultaneous backup recording in HD mode, the duplicate file records in the same file format and bit rate as the original. Backup recording is not available in AVCHD mode.

# Ergonomic Design for Comfortable Operation

## Compact Shoulder Form Factor

The GY-HM850/HM890 features the shoulder-mount form factor that professionals often prefer, in a size that remains compact and light despite its massive capabilities. This combination contributes to stable shooting over long durations with less fatigue. Handle zoom and REC button are also available from low angle shooting.



Picture shows the GY-HM890

## 4 Position ND Filter (Clear, 1/4, 1/16, 1/64)

## High-Resolution 4.3" LCD Monitor

The high-resolution 1.15M-pixel 4.3" LCD monitor displays a wide variety of monitoring and setup indications.



## 0.45" LCOS Viewfinder

The GY-HM850/HM890 is equipped with a high-resolution (852 x 480 x 3) LCOS (Liquid Crystal On Silicon) 0.45" viewfinder. The 16:9 image is crisper and more detailed than conventional LCD viewfinders, with higher vertical resolution and superior RGB colour separation.



## Histogram Display and Expanded Focus Functions

The GY-HM850/HM890 features Histogram Display and Expanded Focus functions to support more accurate focusing.

## Focus Assist Function

When Focus Assist is switched on, the image in the viewfinder of LCD monitor switches to monochrome and all objects that are in focus appear with coloured edges (selectable from red, green or blue). Keeping important elements in the picture in focus while shooting is greatly simplified.



Focus Assist OFF



Focus Assist ON

## Intuitive GUI

The GY-HM850/HM890 features ProHD's highly intuitive GUI navigation system, providing easily accessible menu items and customisable settings to match individual preferences or demands of the moment.

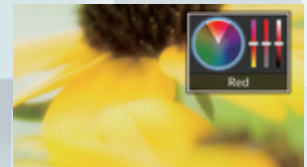
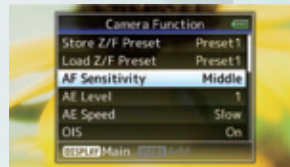

## 12 Assignable User Buttons

## Pre Rec and Interval Rec Modes

With Pre Rec enabled, the camcorder continuously buffers up to 10 seconds of video, so that when recording is started the cached video is included in the recorded file — keeping you from missing a crucial shot because you didn't hit the record button in time. Interval Rec allows you to record single frames at set intervals to capture time-lapse recordings of street traffic, construction sites, growing plants, etc.

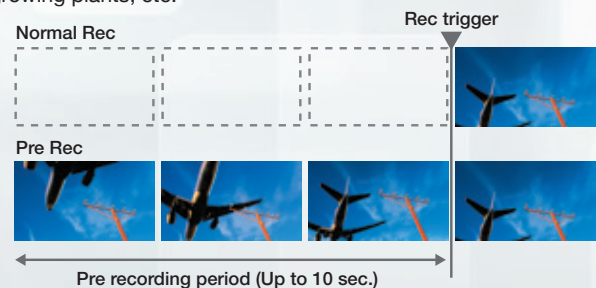



## Variable Frame Rate Recording (Over Cranking, Under Cranking)

When recording in the H.264 1080p 50/35Mbps or MPEG-2 720p 35Mbps mode, the camera can be set to record at a frame rate different than the playback rate. This makes it possible to record slow or fast motion when the recording is played back at 24p, 25p or 30p. Under-cranking in the MPEG-2 1080p 35Mbps mode is also possible.

## Cutting-Edge Connectivity

The GY-HM850/HM890 meets the needs of professional applications with cutting-edge connectivity. For easy monitoring of footage, you can monitor from the digital 3G SDI and HDMI outputs simultaneously, easily switching between output in HD or SD.

- SDI (HD/SD) in\*
- SDI (HD/SD) out
- HDMI (HD/SD) out
- Genlock in
- ITC in/out
- AV out
- USB (Host and Device)
- Mic/Line x 2 with phantom power
- Aux In for Wireless Receiver
- 6-pin and ø2.5mm Remote Control
- ø3.5mm Stereo Headphone out



Picture shows the GY-HM890. SDI input and studio connectors are not available for the GY-HM850.

\*Featured on the GY-HM890 only

## Wired Remote Control Operation

In addition to JVC's proprietary wired remote control system, the GY-HM850/HM890 also supports LANC remote controllers for flexible camera operability in a variety of setups.



## 4-Channel Audio System

The GY-HM850/HM890 is equipped with two XLR audio inputs that are switchable between microphone (with phantom power support) and line input, plus stereo AUX inputs. The audio from each of these inputs can be assigned to an independent channel, enabling commentary or narration to be added in the field.



## Genlock Input and TC Input/Output

Equipped with genlock input and timecode in/out terminals, GY-HM850/HM890 can be easily integrated into multi-camera setups.

## SDI Input GY-HM890

At press conferences and other venues where the number of cameras allowed is limited, the digital audio and video signals from another camera or other SDI source can be recorded or streamed by the GY-HM890.

## ProHD Supporting Software

The ProHD Clip Manager for both Mac and Windows makes it easy to manage MP4 clips on the GY-HM850/HM890's memory cards from your computer. Copy, move, delete, preview clips, and edit clip metadata.

### Main screen for Windows®

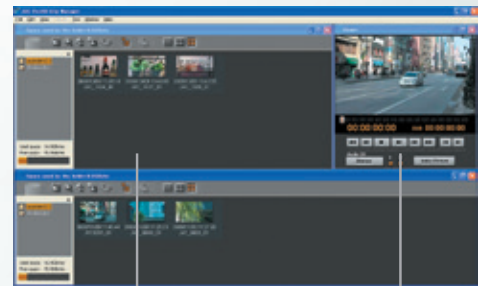

Information window

Viewer window

The ProHD Log and Transfer Plug-in works with Apple's Final Cut Pro™ to enable MP4 files recorded on the GY-HM850/HM890 to be dropped into the clip bin and automatically converted to QuickTime™.

### Log and transfer screen

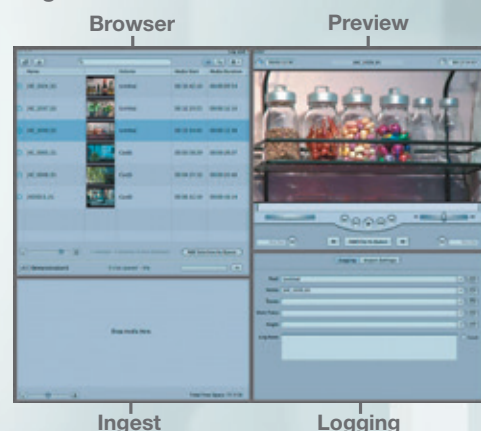

Ingest

Logging

# Network Connectivity & Workflow Outline

## Direct File Transfer from Shooting Location

JVC offers a distinct advantage of having the network connection engine built-in. So it's only necessary to connect either a Wi-Fi, 4G-LTE/3G modem or USB-RJ45 adapter to the USB host interface. No optional backpack is required.

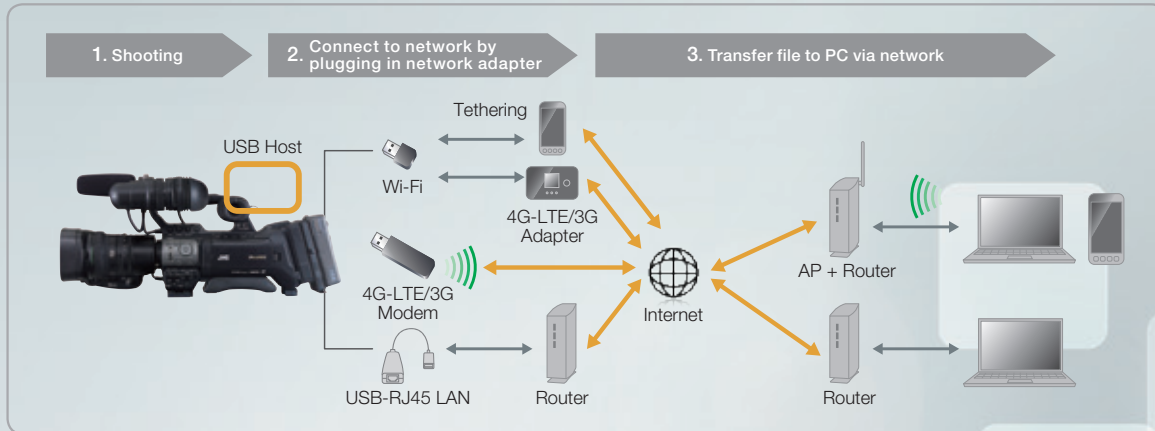

## Camera Control and Metadata Editing via Network

### Camera Picture Viewer/Remote Function

LIVE picture can be viewed on a smartphone or tablet (Android, iPhone, iPad). What's more, REC/PAUSE and ZOOM functions can be controlled from the smart devices via Wi-Fi.



### Metadata Editing and Upload Function

Planning metadata and clip metadata can be edited at a smartphone or tablet and transferred to the camera via 4G-LTE/3G\* or Wi-Fi.



\*Requires acquisition of global IP address.

### Built-in GPS

A GPS unit is built-in, enabling location information to be recorded as metadata along with the video data.



Picture shows the GY-HM890 attached with an optional Wi-Fi adapter.



## Advanced Streaming and Cloud Services

While the GY-HM850/HM890 can record high quality video/audio onto SDHC/SDXC cards, it is also capable of transferring LIVE streaming video/audio via network. Coupled with the superior mobility of the camera, this wireless capability enables faster delivery of LIVE video in mission-critical ENG applications. Stream backhaul LIVE to the newsroom using either Wi-Fi or 4G-LTE network, whichever is more stable and cost-effective in your area. In addition to conventional UDP/TCP support, the GY-HM850/HM890 also supports RTSP/RTP\*1 and Zixi protocols. With built-in Zixi engine, connecting to a 4G-LTE/3G or Wi-Fi network is simply a matter of plugging in a USB network adapter\*2. The technology also allows the GY-HM850/HM890 to be used in conjunction with Zixi's cloud delivery service which enables reliable video delivery over the Internet simply by entering a single IP address. Additional applications such as live, direct-to-website broadcasts and delivery to public internet sites are also supported.

\*1 The camera requires a global IP address in 4G-LTE/3G mode for RTSP/RTP connection.

\*2 Subscription to Zixi services required.

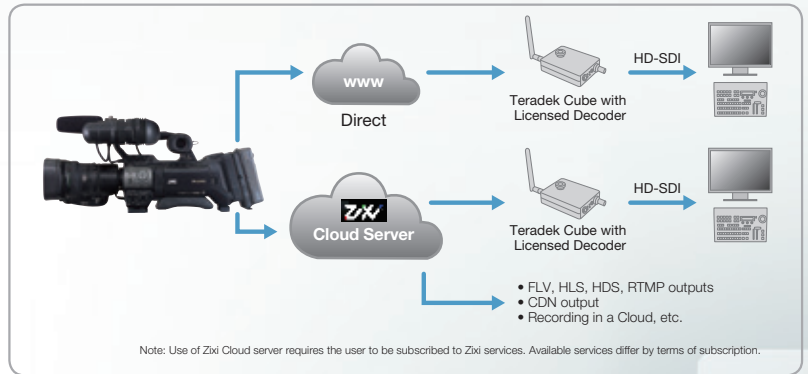
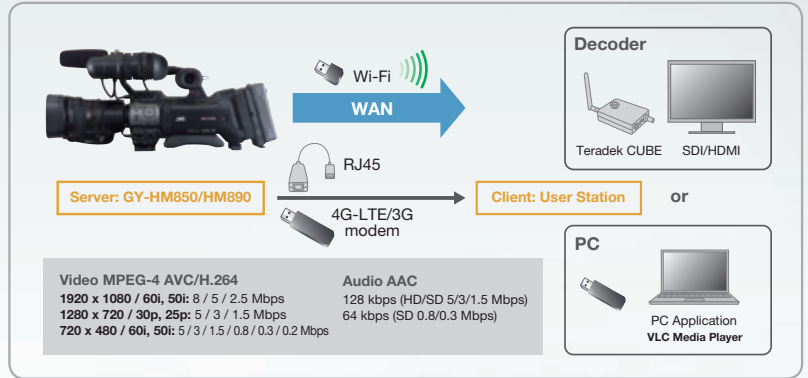

## Dimensions

Unit: mm

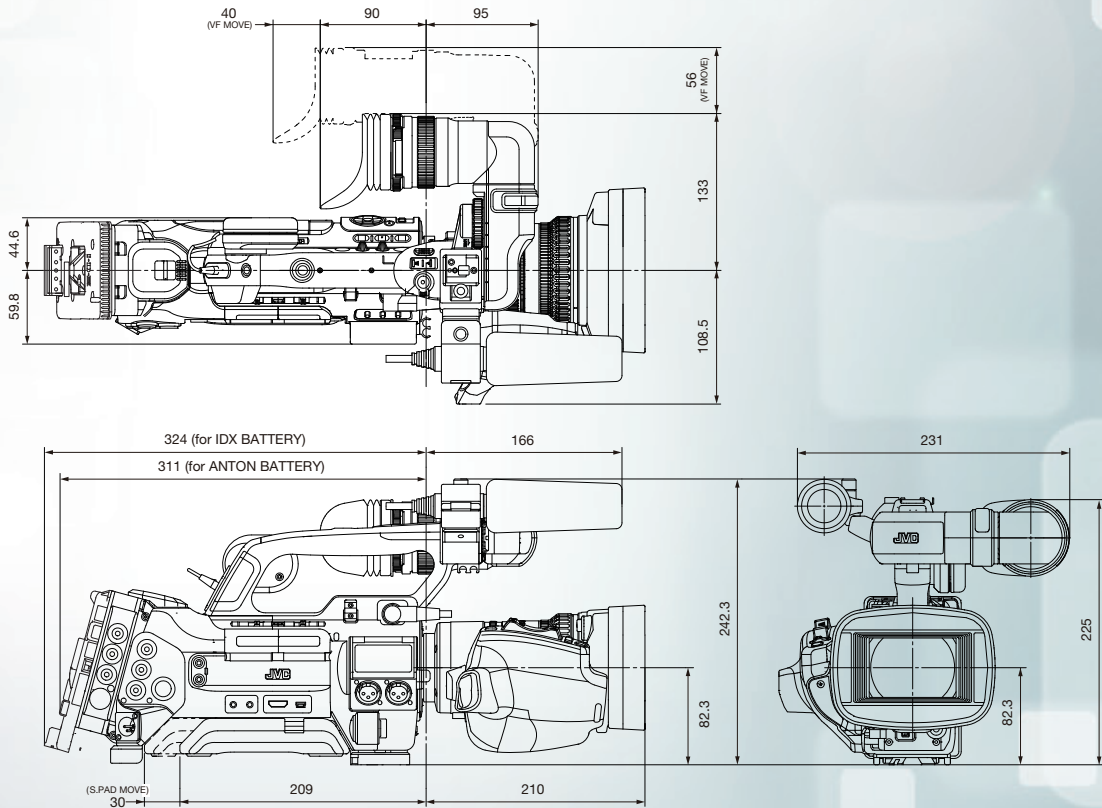

## System Possibilities

### HD/SD ENG System



Photo courtesy of KTUL, Tulsa, Oklahoma

Model	Description
GY-HM850/HM890	HD/SD Memory Card Camcorder

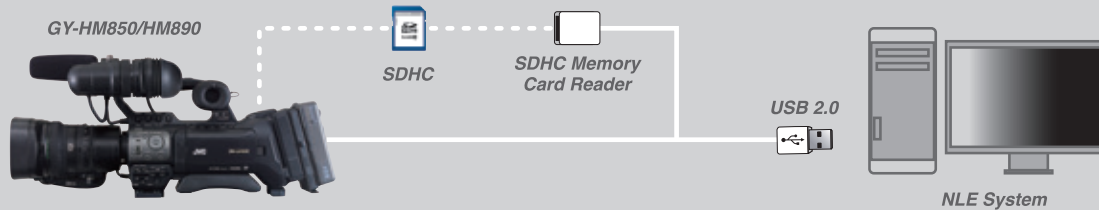

- The GY-HM850/HM890 is an ergonomic shoulder-mount camcorder ideal for ENG applications.
- Both HD or SD recording possible. MOV file format for Apple Final Cut Pro™ in both HD and SD modes. XDCAM EX™-compatible MP4 file for HD and H.264-based MOV format for SD in Windows NLE systems.
- Genlock input and time code input/output available for multi-camera operation.
- SDI input useful for pool feed applications (GY-HM890).

### HD/SD EFP System



Photo courtesy of Riverside Government Television, California

Model	Description	Model	Description
GY-HM890	HD/SD Memory Card Camcorder	RM-HP790	Camera Remote Control Unit
KA-M790G	Multicore Studio Interface Unit Camera Cable	RM-LP25U	Remote Control Unit Switcher
	Multicore/BNC Hybrid Camera Cable		Multi-format Digital Switcher

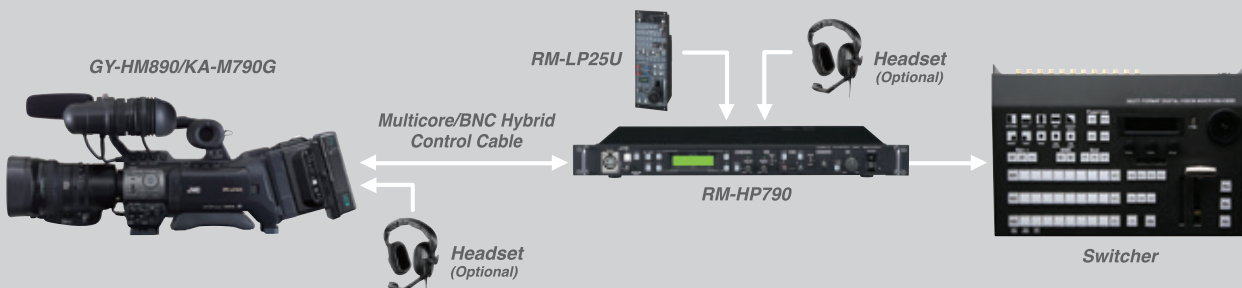

- Fitted with the KA-M790G, the GY-HM890 can be used to construct an economical HD or SD EFP system for stunning images.
- Both HD or SD component and SDI video are supported, giving user flexibility to use component switcher or SDI switcher.
- Lossless SDI output from GY-HM890 can be delivered to RM-HP790 via multicore/BNC hybrid cable
- Flexible shoulder-mounted EFP operation with return video in the provided viewfinder.



# HD/SD Multicore Studio System



Photo courtesy of Ferro Productions, New York



Model	Description	Model	Description
GY-HM890	HD/SD Memory Card Camcorder	Camera Cable	Multicore/BNC Hybrid Camera Cable
KA-M790G	Multicore Studio Interface Unit	RM-HP790	Camera Remote Control Unit
KA-790G	Studio Sled Support	RM-LP25U	Remote Control Unit
VF-HP790G	LCD Studio Viewfinder	Switcher	Multi-format Digital Switcher

- Fitted with the KA-M790G and the KA-790G, the GY-HM890 can be used to construct an economical HD or SD studio system for stunning images.
- Both HD or SD component and SDI video are supported, giving user flexibility to use a component switcher or SDI switcher.
- Lossless SDI output from GY-HM890 can be delivered to RM-HP790 via multicore/BNC hybrid cable

- When connecting KA-M790G to a RM-HP790 unit, users' existing 26-pin Sony cable can be used.
- Reliable tripod-mounted studio operation with pedestal and teleprompter.
- When needed, the GY-HM890 can be used as an ENG camera by releasing the camera from KA-790G.

# HD/SD Fibre Studio System



Photo courtesy of Loyola Studio, Maryland

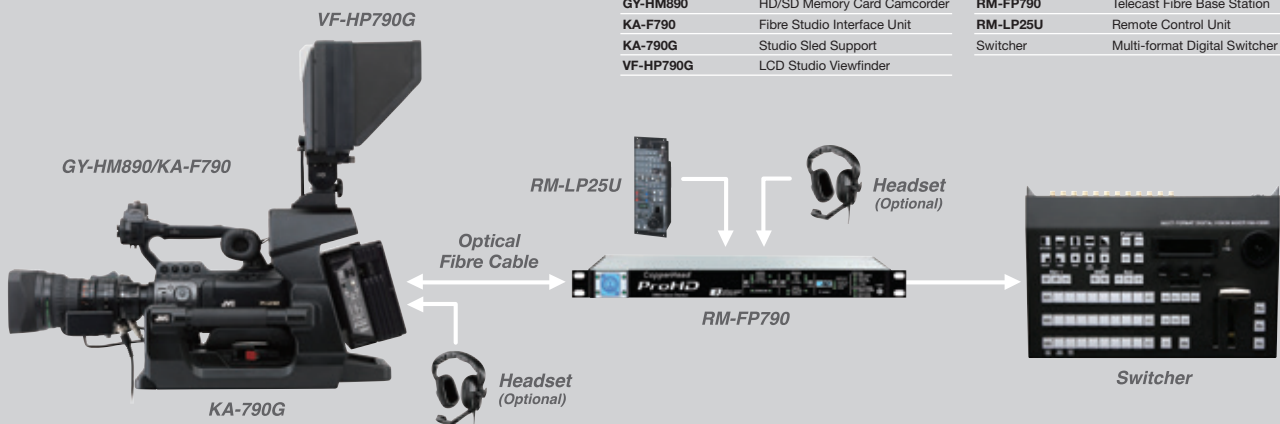

Model	Description	Model	Description
GY-HM890	HD/SD Memory Card Camcorder	RM-FP790	Telecast Fibre Base Station
KA-F790	Fibre Studio Interface Unit	RM-LP25U	Remote Control Unit
KA-790G	Studio Sled Support	Switcher	Multi-format Digital Switcher
VF-HP790G	LCD Studio Viewfinder		

- Fitted with the KA-F790 and the KA-790G, the GY-HM890 can be converted into an economical HD or SD studio system.
- Both HD or SD component and SDI video are supported, providing flexibility to use a component switcher or SDI switcher.

- Optical fibre system allows longer cable distance operation with optional Power Wafer.
- When needed, the GY-HM890 can be used for ENG by releasing the camera from the KA-790G studio sled support.

# System Configuration

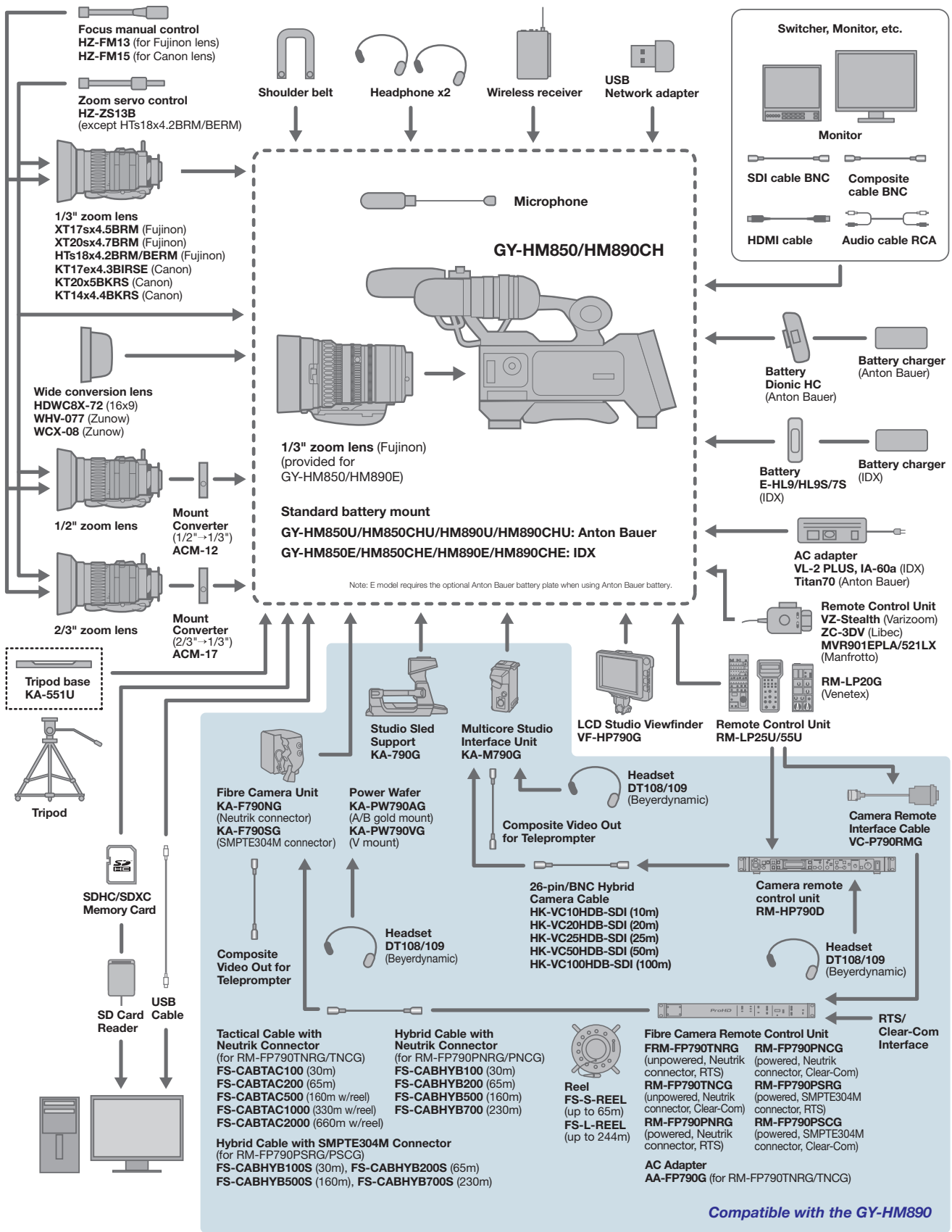



# Options



(Fujinon)

**HTs18x4.2BRM**  
**HTs18x4.2BERM** (2x extender)  
 1/3" high quality zoom lens



(Fujinon)

**XT17sx4.5BRM**  
**XT20sx4.7BRM**  
 1/3" zoom lens



(Canon)

**KT17ex4.3BIRSE**  
 1/3" high quality zoom lens  
 with 2x extender



(Canon)

**KT20x5BKRS**  
**KT14x4.4BKRS**  
 1/3" zoom lens



HDWC8X-72

**WHV-077** (Zunow)  
**WCX-08** (Zunow)  
**HDWC8X-72** (16x9)  
 Wide conversion lens



**ACM-12**  
 1/2" bayonet mount  
 converter



**ACM-17**  
 2/3" bayonet mount  
 converter



**HZ-ZS13BU**  
 Manual zoom control  
 Cannot be used for HTs18x4.2BRM lens.  
 Use Fujinon ZMM-6: Module unit/  
 CZH-14: Grip/CFC-12-990: Cable/  
 MCA-7: Mounting clamp



**HZ-FM13U** (Fujinon)  
**HZ-FM15U** (Canon)  
 Manual focus control  
 For optional lens only. Cannot be used  
 for KT17ex4.3BIRSE lens.  
 Use Canon FFM-100: Flex focus module/  
 FC-40: Flex cable/FFC-200: Flex focus  
 controller



**KA-M790G**  
 Multicore studio interface  
 unit



**KA-790G**  
 Studio sled support



**RM-HP790**  
 Camera control unit



**VZ-Stealth** (Varizoom)  
**ZC-3DV** (Libec)  
**MVR901EPLA** (Manfrotto)  
 Remote control unit



**RM-LP25U**  
**RM-LP55U**  
**RM-LP20G** (Venetex)  
 Remote control unit



**VF-HP790G**  
 8.4" LCD studio viewfinder



**FS-790**  
 Telecast fibre studio system

**FS-CABTAC100** (100 feet)  
**FS-CABTAC200** (200 feet)  
**FS-CABTAC500** (500 feet)  
**FS-CABTAC1000** (1000 feet)  
**FS-CABTAC2000** (2000 feet)  
 Fibre cables (Tactical cable)

**FS-CABHYB100** (100 feet)  
**FS-CABHYB200** (200 feet)  
**FS-CABHYB500** (500 feet)  
**FS-CABHYB700** (700 feet)  
 Fibre cables  
 (Hybrid cable/Optical CON)

**FS-CABHYB100S** (100 feet)  
**FS-CABHYB200S** (200 feet)  
**FS-CABHYB500S** (500 feet)  
**FS-CABHYB700S** (700 feet)  
 Fibre cables  
 (Hybrid cable/SMPT304M)

**HK-VC10HDB-SDI** (10 m)  
**HK-VC20HDB-SDI** (20 m)  
**HK-VC25HDB-SDI** (25 m)  
**HK-VC50HDB-SDI** (50 m)  
**HK-VC100HDB-SDI** (100 m)  
 Multicore hybrid cable



**KA-551U**  
 Tripod base  
 V-mount adapter



**QR JVCDIGI**  
 Anton Bauer  
 Gold Mount plate



**SR-HD1350**  
**SR-HD1700**  
**SR-HD2500**  
 Blu-ray disc & HDD recorder



**DT-V24G1E/V21G11E/**  
**V17G15E/V17G1E/**  
**V9L5E/F9L5E**  
 LCD HD monitor



**DT-R24L41DE**  
**DT-E21L4E/E17L4GE/**  
**E15L4E**  
 LCD HD monitor



**E-HL9/HL9S/7S**  
 IDX battery



**VL-2PLUS**  
 IDX V-mount battery  
 charger/AC adapter



**Dionics HC**  
 Anton Bauer battery



**Tandem 70**  
 Anton Bauer battery  
 charger/AC adapter



**IA-60a**  
 IDX AC adapter

# GY-HM890/HM850 Specifications

## General

Power: DC 12V (10.5V-17V)  
 Power consumption: Approx. 28W  
 (Camera body with provided lens and LCD/VF ON,  
 single recording mode, default settings)  
 Mass: Approx. 4.0kg (8.9lbs.) (without battery)  
 Approx. 4.8kg (10.6lbs.) (including battery)  
 Operating temperature: 0°C to 40°C  
 Operating humidity: 35% to 80%  
 Storage temperature: -20°C to 50°C  
 Storage humidity: Under 85%

## Camera

Image sensor: 1/3" 2.2M pixels progressive scan 3CMOS  
 Synchronising system: Internal/external synchronisation  
 Stabiliser: Optical image stabiliser  
 Lens: Fujinon F1.6-3.0, 20x (interchangeable),  
 f=4.1-82mm (35mm conversion: 29 to 580mm)  
 Sensitivity: F11 (60Hz)/F12 (50Hz), 2000lx (typical; Extended mode)  
 Minimum illumination: 0.15lx (typical; 1920 x 1080 mode, F1.6,  
 Lolux mode with 1/30 or 1/25 shutter)  
 Shutter speed: 1/4 to 1/10000  
 Filter diameter: 72mm  
 Gain: -6, -3, 0, 3, 6, 9, 12, 15, 18 dB, Lolux, ALC  
 ND filter: Clear, 1/4, 1/16, 1/64  
 LCD display: 4.3" 1.15M pixels  
 Viewfinder: 0.45" 1.22M pixels

## Video/Audio Recording

Recording media: 2x SDHC/SDXC memory card Class 4/6/10  
 (Class 4 for AVCHD and H.264 SD/Web only)  
 Video recording:  
 Video codec: MPEG-2 Long GOP (HD), AVCHD progressive, H.264  
 File format: MOV (HD/SD/WEB), MP4 (XDCAM EX),  
 MTS (AVCHD progressive), MXF  
 Recording mode:  
**MPEG-2 Long GOP**  
 PAL setting: HQ mode: 1920 x 1080/50i, 25p, 1440 x 1080/50i,  
 1280 x 720/50p, 25p  
 SP mode: 1440 x 1080/50i, 1280 x 720/50p  
 NTSC setting: HQ mode: 1920 x 1080/59.94i, 29.97p, 23.98p,  
 1440 x 1080/59.94i, 1280 x 720/59.94p,  
 29.97p, 23.98p  
 SP mode: 1440 x 1080/59.94i, 1280 x 720/59.94p

## AVCHD

PAL setting: Progressive mode (Max 28Mbps): 1920 x 1080/50p  
 HQ mode (24Mbps): 1920 x 1080/50i  
 SP mode (17Mbps): 1920 x 1080/50i  
 LP mode (9Mbps): 1440 x 1080/50i  
 EP mode (5Mbps): 1440 x 1080/50i  
 NTSC setting: Progressive mode (Max 28Mbps): 1920 x 1080/59.94p  
 HQ mode (24Mbps): 1920 x 1080/59.94i  
 SP mode (17Mbps): 1920 x 1080/59.94i  
 LP mode (9Mbps): 1440 x 1080/59.94i  
 EP mode (5Mbps): 1440 x 1080/59.94i

## HD (H.264)

PAL setting: XHQ mode: 1920 x 1080/50p, 50i, 25p (50Mbps)  
 UHQ mode: 1920 x 1080/50i, 25p (35Mbps)  
 NTSC setting: XHQ mode: 1920 x 1080/59.94p, 59.94i, 29.97p,  
 23.98p (50Mbps)  
 UHQ mode: 1920 x 1080/59.94i, 29.97p, 23.98p  
 (35Mbps)

## SD (H.264)

PAL setting: 720 x 576/50i (GY-HM850E/HM890E only)  
 NTSC setting: 720 x 480/59.94i (GY-HM850U/HM890U only)

## Web (H.264)

PAL setting: HQ mode (3Mbps): 960 x 540/25p  
 LP mode (1.2Mbps): 480 x 270/25p  
 NTSC setting: HQ mode (3Mbps): 960 x 540/29.97p, 23.98p  
 LP mode (1.2Mbps): 480 x 270/29.97p, 23.98p  
 Audio recording: LPCM 2ch/4ch, 48kHz/16-bit (MPEG-2 Long GOP/  
 H.264), AC3 2ch (AVCHD),  $\mu$ -law 2ch/4ch (Web)

## Interface

Video input: SDI input (BNC x1) (GY-HM890 only)  
 Video output: Composite output (BNC x 1), 3G SDI output (BNC x 1),  
 HDMI output x 1  
 Audio input: XLR 3-pin x 2, (MIC,+48V, LINE)/ $\phi$ 3.5mm mini jack x 1  
 Audio output: RCA x 2  
 Headphone:  $\phi$ 3.5mm mini jack x 2  
 Genlock input: BNC x 1  
 Time code input/output: BNC x each 1  
 Remote: DIN 6-pin x 1/ $\phi$ 2.5mm mini jack x 1  
 USB: HOST x 1 (Network connection)/DEVICE x 1 (Mass storage)  
 DC input: XLR 4-pin x1

## Provided Accessories

Microphone x 1

## SDHC Class 4/6/10 and SDXC approximate recording time (When number of audio channel is set to 4channel.)

	MOV/MP4			MOV		MTS					MOV	MOV	
	MPEG-2/HD			H.264/HD		AVCHD					H.264/SD	H.264/Web	
	HQ	SP		XHQ	UHQ	Progressive	HQ	SP	LP	EP	SD	Web	
	720p/1080i	1080i	720p	1080p/i	1080p/i	1080p	1080i	1080i	1080i	1080i	480i/576i	540p	270p
4GB	12 min.	16 min.	20 min.	8 min.	12 min.	16 min.	19 min.	25 min.	46 min.	1 hr. 22 min.	40 min.	2 hr.	4 hr.
8GB	24 min.	32 min.	40 min.	17 min.	24 min.	33 min.	39 min.	50 min.	1 hr. 35 min.	2 hr. 48 min.	1 hr. 20 min.	4 hr.	8 hr.
16GB	48 min.	1 hr. 4 min.	1 hr. 20 min.	35 min.	48 min.	1 hr. 7 min.	1 hr. 18 min.	1 hr. 40 min.	3 hr. 10 min.	5 hr. 36 min.	2 hr. 40 min.	8 hr.	16 hr.
32GB	1 hr. 36 min.	2 hr. 10 min.	2 hr. 40 min.	1 hr. 10 min.	1 hr. 36 min.	2 hr. 15 min.	2 hr. 36 min.	3 hr. 20 min.	6 hr. 20 min.	11 hr. 12 min.	5 hr. 20 min.	16 hr.	32 hr.
64GB (SDXC)	3 hr. 12 min.	4 hr. 20 min.	5 hr. 20 min.	2 hr. 20 min.	3 hr. 12 min.	4 hr. 30 min.	5 hr. 12 min.	6 hr. 40 min.	12 hr. 40 min.	22 hr. 24 min.	10 hr. 40 min.	32 hr.	64 hr.
128GB (SDXC)	6 hr. 24 min.	8 hr. 40 min.	10 hr. 40 min.	4 hr. 40 min.	6 hr. 24 min.	9 hr.	10 hr. 32 min.	13 hr. 20 min.	25 hr. 20 min.	44 hr. 48 min.	21 hr. 20 min.	64 hr.	128 hr.

Note: Class 4 corresponds to AVCHD/H.264 SD and Web modes only. Class 10 or more is required for XHQ mode recording.

Microsoft® and Windows® are either registered trademarks or trademarks of Microsoft Corporation in the United States and/or other countries.  
 Apple, Apple logo, Macintosh, QuickTime, and Final Cut Pro are trademarks of Apple Inc. registered in the United States and other countries.  
 The SD, SDHC and SDXC are trademarks of the SD Card Association.  
 \*AVCHD Progressive\* and \*AVCHD Progressive\* logo are trademarks of Panasonic Corporation and Sony Corporation.  
 HDMI, the HDMI logo and High-Definition Multimedia Interface are trademarks or registered trademarks of HDMI Licensing LLC.  
 Dolby is a registered trademark of Dolby Laboratories.  
 Product and company names mentioned here are trademarks or registered trademarks of their respective owners.  
 XDCAM EX is a trademark of Sony Corporation.  
 Zixi and the Zixi logo are trademarks of Zixi LLC.

Simulated pictures.

The values for weight and dimensions are approximate.  
 E.&O.E. Design and specifications subject to change without notice.



DISTRIBUTED BY